

Quick Start Guide

Ethernet Switch

AS7535-28XB | AS7535-28XBE



www.edge-core.com

Package Contents



1



2



3



4



5

1. AS7535-28XB/AS7535-28XBE (includes 2 PSUs and 6 fan trays)
2. Rack Mounting Kit—2 brackets and 8 screws
3. Grounding kit—grounding lug, 2 screws, and 2 washers

4. (Optional) AC power cord
5. Documentation—*Quick Start Guide* (this document) and *Safety and Regulatory Information*

Overview

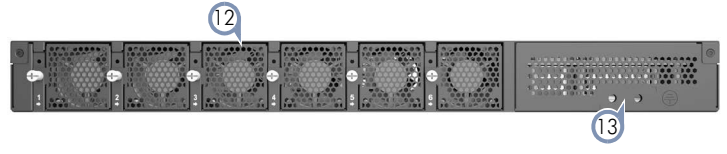
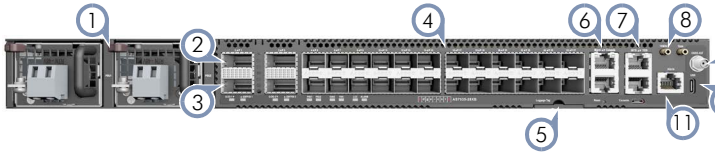

1. 2 x DC or AC PSUs
2. 2 x 100G QSFP28 ports
3. 2 x 400G QSFP-DD ports
4. 24 x 25G SFP28 ports
5. Product tag
6. Management I/O: 1000BASE-T RJ-45, RJ-45 console, Micro-USB console, reset button

7. BITS/ToD RJ-45 timing ports
8. 10MHz/1PPS I/O
9. GNSS antenna
10. USB Type C storage port
11. RJ-45 alarm port
12. 6 x fan trays
13. Grounding screw

Status LEDs

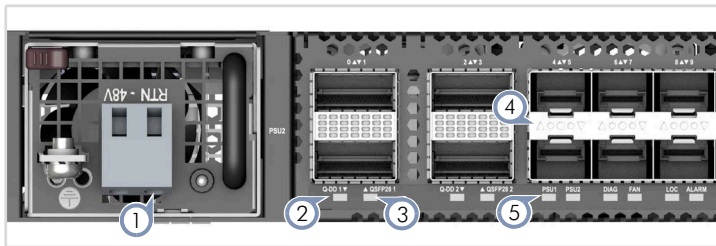

1. **PSU LED:** Green (OK), Amber (fault)
2. **QSFP-DD Port LEDs:** Blue (400G), Cyan (200G), Green (100G), Yellow (50G)
3. **QSFP28 Port LEDs:** Green (100G), Cyan (50G), Magenta (40G), Blue (25G), Yellow (10G)
4. **SFP28 Port LEDs:** Blue (25G), Green (10G), Cyan (1G)

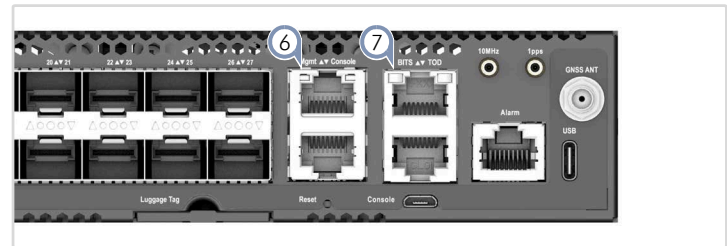

5. **System LEDs:**
PSU1/2 — Green (OK), Amber (fault)
DIAG — Green (OK), Orange (fault detected)
FAN — Green (OK), Orange (fault)
LOC — Blinking Blue (OK)
ALARM — Green (OK), Red (alarm)
6. **RJ-45 Management Port LEDs:** Left (link), Right (activity)
7. **BITS/ToD LEDs:** Green (valid BITS), Blinking Green (1PPS ToD)

FRU Replacement

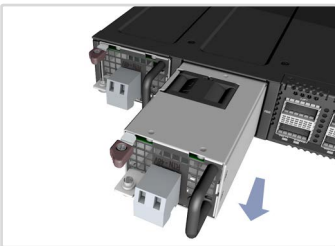

PSU Replacement

1. Remove the power cord.
2. Press the release latch and remove the PSU.
3. Install replacement PSU.

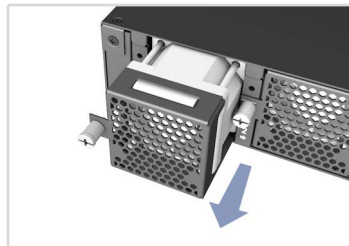

Fan Tray Replacement

1. Loosen the fan tray screw.
2. Pull out and remove the fan tray.
3. Install replacement fan tray.



* 1 5 0 2 0 0 0 0 2 4 8 9 A R 0 2 *

Installation



Warning: For a safe and reliable installation, use only the accessories and screws provided with the device. Use of other accessories and screws could result in damage to the unit. Any damages incurred by using unapproved accessories are not covered by the warranty.

Avertissement: Pour une installation sûre et fiable, utilisez uniquement les accessoires et les vis fournies avec l'appareil. L'utilisation d'autres accessoires et vis pourrait endommager l'appareil. Les dommages causés par l'utilisation d'accessoires non approuvés ne sont pas couverts par la garantie.



Caution: The device must be installed in a restricted-access location.

Attention: L'appareil doit être installé dans un emplacement à accès restreint.



Note: The device has the Open Network Install Environment (ONIE) software installer preloaded, but no software image. Information about compatible software can be found at www.edge-core.com.



Note: The drawings in this document are for illustration only and may not match your particular model.

1 Mount the Device in an EIA-310 Rack

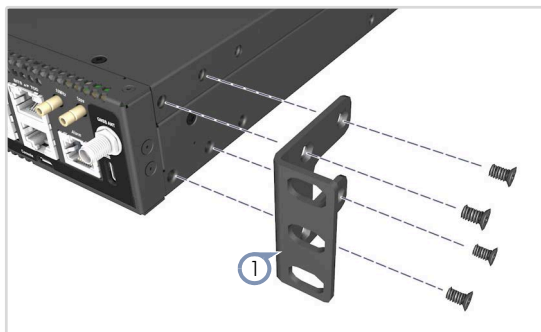

- For a 300mm-deep rack, use the four front screw holes to attach each of the brackets to the device with four of the included bracket screws. (For a 280mm-deep rack, use the four recessed screw holes.)

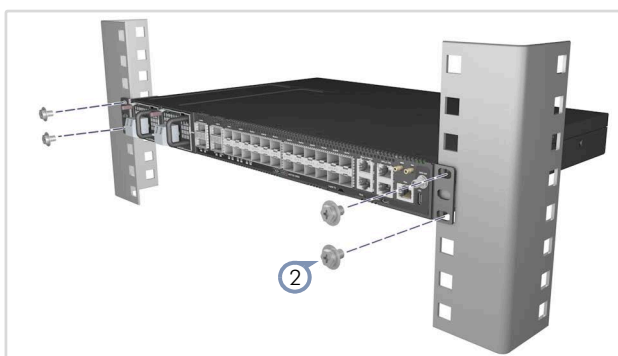

- Use the screws and cage/clip nuts supplied with the rack to secure the device in the rack.

2 Ground the Device

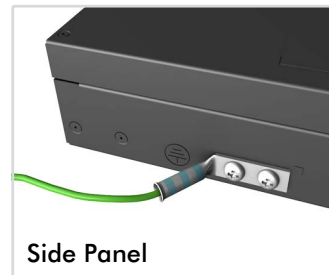
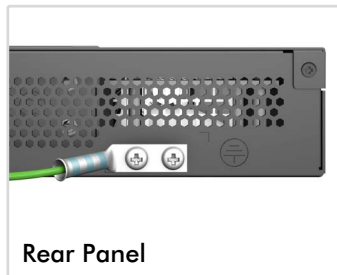

Verify Rack Ground

Ensure the rack is properly grounded and in compliance with international and local standards. Verify that there is a good electrical connection to the grounding point on the rack (no paint or isolating surface treatment).

Attach Grounding Wire

Attach the grounding wire (#14 AWG/1.5 mm², green with yellow stripe) to the grounding point on the device's rear panel or side panel. Then connect the other end of the wire to rack ground.



Caution: The earth connection must not be removed unless all supply connections have been disconnected.

Attention: Le raccordement à la terre ne doit pas être retiré sauf si toutes les connexions d'alimentation ont été débranchées.

3 Connect Power

a. AC Power

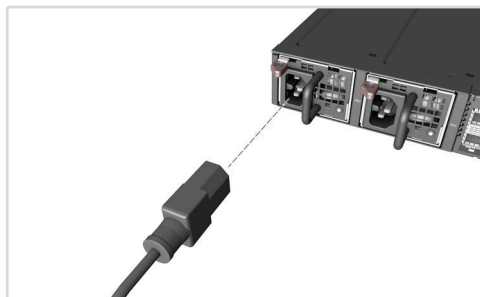

Install one or two AC PSUs in the device, if they are not already installed in the factory. Then connect an external AC power source to the PSUs.

b. DC Power

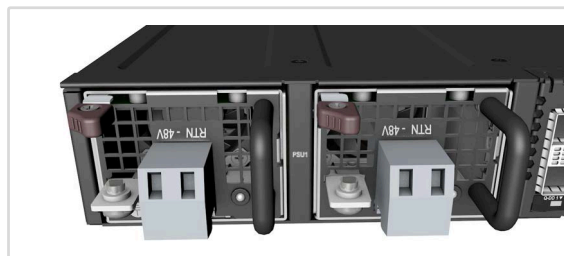

Install one or two DC PSUs in the device, if they are not already installed in the factory.

Connect an external DC power source to the PSUs. Or, connect to a no-tolerance DC mains supply with a UL/CSA-approved circuit breaker rated at 16 A.

Caution: Before connecting power supply cables to the device, ensure that power to the feed lines is turned off at the supply circuit breaker or disconnected from the power bus.

Attention: Avant de connecter les câbles d'alimentation à l'appareil, assurez-vous que l'alimentation des lignes d'alimentation est coupée au niveau du disjoncteur d'alimentation ou déconnectée du bus d'alimentation.

Caution: Use a UL/IEC/EN 60950-1 and/or 62368-1 certified power supply to connect to a DC converter, and a #14 AWG/1.5 mm² (for -44 VDC to -60 VDC PSU) wire to connect to a DC PSU.

Attention: Utilisez une alimentation certifiée UL/IEC/EN 60950-1 et/ou 62368-1 pour le connecter à un convertisseur CC et un câble AWG #14/1.5 mm² (pour -44 VDC à -60 VDC) pour vous connecter à une alimentation CC.

Caution: All DC power connections should be performed by a qualified professional.

Attention: Toutes les connexions d'alimentation CC doivent être effectuées par un professionnel qualifié.

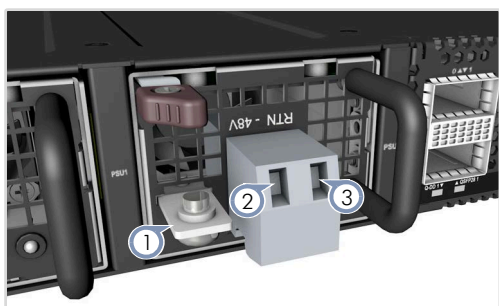

1. Connect the ground wire / protective earth.
2. Connect the -44 – -60 VDC wire.
3. Connect the DC return wire.

Note: It is suggested to use the following for DC power:
 One UL 1015 AWG#10-14 stranded wire, 2m maximum (-44VDC – -60VDC: Input+)
 One UL 1015 AWG#10-14 stranded wire, 2m maximum (VDC return: Input-)
 One UL 1015 AWG#10-14 stranded wire, 2m maximum, (green/yellow) green with yellow stripe (PE)

Note: The DC terminal screws should be tightened to a torque of 7 in-lbs maximum.

4 Make Network Connections

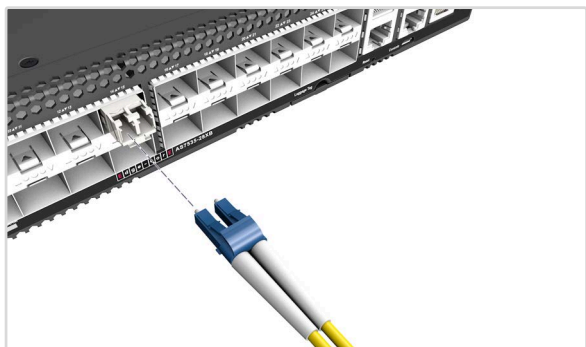

QSFP-DD/QSFP28/SFP28 Ports

Install transceivers and then connect fiber optic cabling to the transceiver ports. Alternatively, connect AEC/AOC/DAC cables directly to the QSFP-DD/QSFP28/SFP28 slots.

The following transceivers are supported in the QSFP-DD ports:

- 400GBASE-SR8, DR4, FR4, AEC cable

The following transceivers are supported in the QSFP28 ports:

- 100GBASE-SR4, PSM4, LR4, ER4, ZR4, CR4, AOC
- 40GBASE-SR4, PSM4, LR4

The following transceivers are supported in the SFP28 ports:

- 25GBASE-SR, LR, BX BiDi
- 10GBASE-SR, LR, CR, BX BiDi, T
- 1000BASE-SX, LX, BX BiDi, T

5 Connect Timing Ports

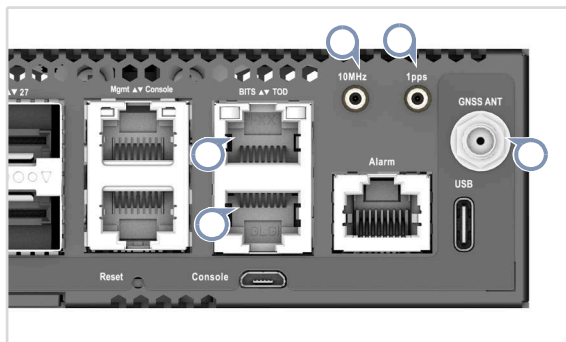

RJ-45 BITS/ToD

Use Cat. 5e or better twisted-pair cables to connect the Building-Integrated Timing Supply (BITS) and Time of Day (ToD) ports to other synchronized devices.

10MHz/1pps

Use coax cables to connect the 10 MHz and 1-pulse-per-second (1PPS) ports to other synchronized devices.

GNSS Antenna

Attach an external antenna to the GNSS antenna port for clock synchronization with GPS time.

6 Make Management Connections

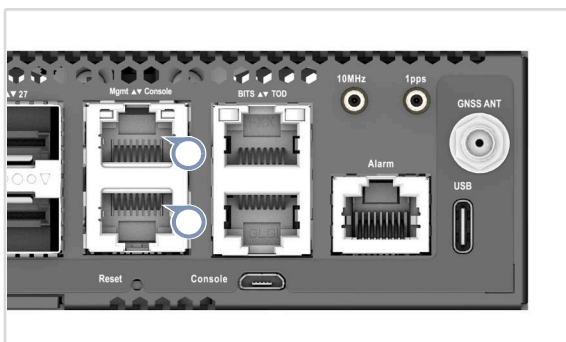

Mgmt RJ-45 Port

Connect Category 5, 5e or better twisted-pair cable.

RJ-45 Console Port

Use an RJ-45-to-DB-9 null-modem console cable (not included) to connect to a PC running terminal emulator software. Use a USB-to-male DB-9 adapter cable (not included) for connections to PCs that do not have a DB-9 serial port.

Configure the serial connection: 115200 bps, 8 characters, no parity, one stop bit, 8 data bits, and no flow control.

Console cable pinouts and wiring:

Device's RJ-45 Console	Null Modem	PC's 9-Pin DTE Port
6 RXD (receive data)	<-----	3 TXD (transmit data)
3 TXD (transmit data)	----->	2 RXD (receive data)
4,5 SGND (signal ground)	-----	5 SGND (signal ground)

Hardware Specifications

Size (WxDxH)	438.4 x 300 x 43.3 mm (17.26 x 11.81 x 1.7 in.)
Weight	6.8 kg (14.99 lb), with two installed PSUs
Temperature	Operating: -40° C to 65° C (-40° F to 149° F) Transportation: -40° C to 85° C (-40° F to 185° F) Storage: -40° C to 85° C (-40° F to 185° F)
Humidity	Operating: 5% to 95% (non-condensing)
Power Consumption (at 25° C)	Maximum: 383.6 W Typical: 164.03 W Minimum: 95.11 W
System Input Rating	AC Input: 100–240 VAC, 50–60 Hz, 6.0–2.4 A 100-120 VAC, 50/60 Hz, 6.0 A Max or 200-240 VAC, 50/60 Hz, 3.0 A Max DC Input: -44 – -60 VDC, 15.5–9.6 A

Regulatory Compliances

Emissions	EN 55032 EN 61000-3-2 EN 61000-3-3 FCC Title 47, Part 15, Subpart B, Class A VCCI-CISPR 32 BSMI Class A
Immunity	EN 55035 IEC 61000-4-2/3/4/5/6/8/11
Environmental	Storage: ■ ETSI EN 300 019-1-1 Class 1.1 ■ Temperature: -40° C to 85° C (-40° F to 185° F) Transportation: ■ ETSI EN 300 019-1-2 Class 2.3 ■ Temperature: -40° C to 85° C (-40° F to 185° F) Operating Conditions: ■ ETSI EN 300 019-1-3 Class 3.2 ■ Temperature: -40° C to 65° C (-40° F to 149° F) ■ Relative Humidity: 5% to 95%
Safety	UL (CSA 22.2 No 62368-1 & UL 62368-1) CB (IEC/EN 62368-1, 2nd & 3rd Ed) BSMI CNS 15598-1

Warranty Information and Technical Support

Registering your product enables you to receive a more efficient warranty service. Be sure to register at www.edge-core.com.

快速入門指南

乙太網路交換器

AS7535-28XB | AS7535-28XBE

包裝內容物

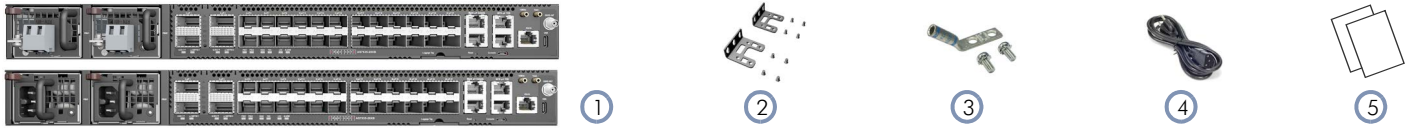

1. AS7535-28XB/AS7535-28XBE (包括 2 個 PSU 及 6 個風扇托盤)
2. 機櫃安裝套件 — 2 個托架和 8 個螺絲
3. 接地單元 — 接地壓耳、2 顆螺絲和 2 個墊圈
4. (選配) AC 電源線
5. 文件 - 快速入門指南 (本文件) 及安全及法規資訊

簡介

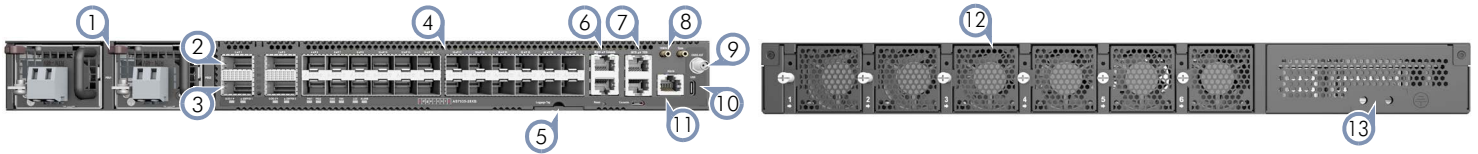

1. 2 x DC 或 AC PSU
2. 2 x 100G QSFP28 連接埠
3. 2 x 400G QSFP-DD 連接埠
4. 24 x 25G SFP28 連接埠
5. 產品標籤
6. 管理 I/O : 1000BASE-T RJ-45 · RJ-45 控制埠 · Micro-USB 主控台、重置按鈕
7. BITS/ToD RJ-45 時序連接埠
8. 10MHz/1PPS I/O
9. GNSS 天線
10. USB Type C 儲存連接埠
11. RJ-45 警報連接埠
12. 6 x 風扇托盤
13. 接地螺絲

LED 指示燈的狀態說明

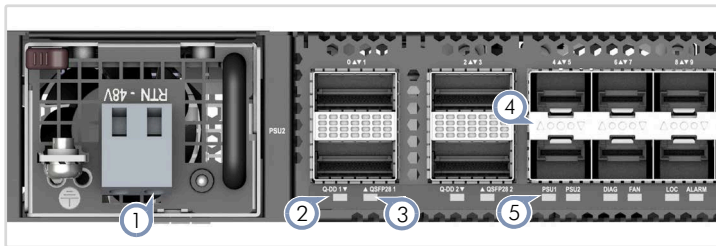

1. PSU LED : 綠燈 (OK) · 黃燈 (故障)
2. QSFP-DD 連接埠 LED : 藍燈 (400G) · 青燈 (200G) · 綠燈 (100G) · 黃燈 (50G)
3. QSFP28 連接埠 LED : 綠燈 (100G) · 青燈 (50G) · 洋紅燈 (40G) · 藍燈 (25G) · 黃燈 (10G)
4. SFP28 連接埠 LED : 藍燈 (25G) · 綠燈 (10G) · 青燈 (1G)

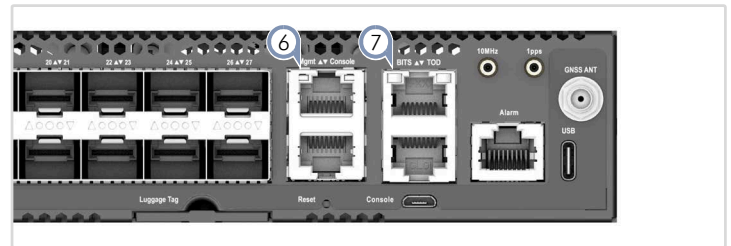

5. 系統 LED :
PSU1/2 — 綠燈 (良好) · 黃燈 (故障)
DIAG — 綠燈 (良好) · 橘燈 (偵測到故障)
FAN — 綠燈 (良好) · 橘燈 (故障)
LOC — 閃爍藍燈 (良好)
警報 — 綠燈 (良好) · 紅燈 (警報)
6. RJ-45 管理連接埠 LED : 左 (連結) · 右 (活動)
7. BITS/ToD LED : 綠燈 (有效 BITS) · 閃爍綠燈 (1PPS ToD)

更換 FRU

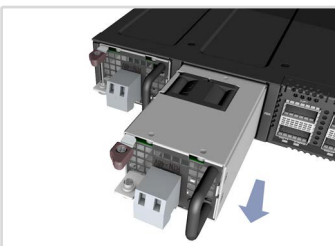

更換 PSU

1. 取下電源線。
2. 按住釋放桿並取出 PSU。
3. 安裝更換的 PSU。

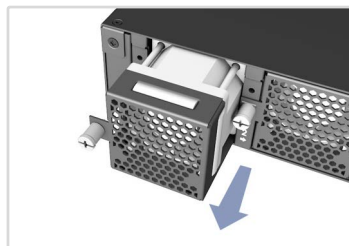

更換風扇托盤

1. 鬆開風扇托盤螺絲。
2. 拉出並拆下風扇托盤。
3. 安裝更換的風扇托盤。

安裝



警告：為確保安全且可靠的安裝，請使用裝置隨附的配件與螺絲。使用其他來源的配件與螺絲可能導致配件損壞。使用未經許可配件所造成之損壞，不在保固範圍內。



注意：裝置必須安裝在限制出入地點。



注釋：本裝置預先安裝了「開放網路安裝環境 (Open Network Install Environment, ONIE)」軟體安裝程式，但沒有軟體圖示。關於相容軟體的資訊，可上此網站：www.edge-core.com。



注釋：本文件中的示意圖僅供參考，可能與特定型號有所差異。

1 將裝置安裝到 EIA-310 機櫃上

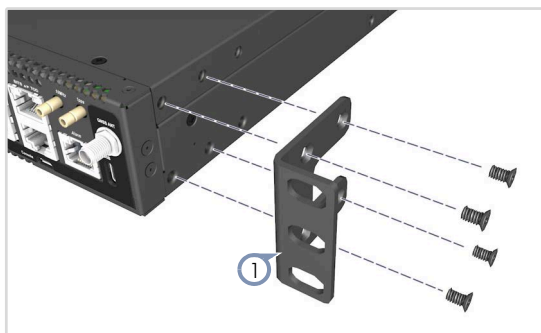

1. 如為深度 300mm 的機架，請使用四個前段螺絲孔，用四顆隨附的托架螺絲將每個托架安裝到裝置上。(如為深度 280mm 的機架，則使用四個凹式螺絲孔。)

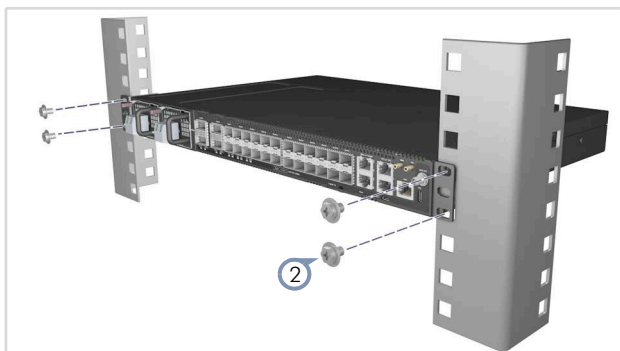

2. 使用機櫃隨附提供的螺絲與支架 / 彈簧夾螺帽將裝置固定於機櫃上。

2 將裝置接地



確認機架接地

請確保機櫃正確接地，並符合國際與當地標準。確認與機櫃接地點間有良好的電氣連接性（無油漆或絕緣表面處理）。

安裝接地線

將接地線（#14 AWG/1.5 mm²，綠色及黃色條紋）安裝在裝置後面板或側面板接地點上。接下來，將接地線另一端連接至機櫃接地。



注意：在切斷所有電源接線前，不得移除接地連接。

3 連接電源

a. AC 電源

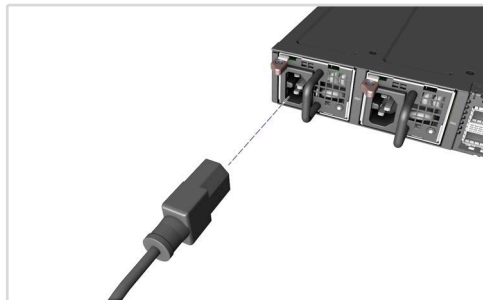

若尚未在原廠中安裝，請在裝置中安裝一或兩部 AC PSU。然後將外部 AC 電源連接至 PSU。

b. DC 電源



若尚未在原廠中安裝，請在裝置中安裝一或兩部 DC PSU。

將外部 DC 電源連接至 PSU。或將無容差 DC 主電源連接具備 UL/CSA 標準認證的 16A 斷路器。



注意：將電源供應器纜線連接到裝置前，請務必在電源斷路器關閉連接到饋線的電源，或從電源匯流排切斷電源。



注意：使用 UL/IEC/EN 60950-1 及 / 或 62368-1 認證電源連接至 DC 轉換器，並使用 #14 AWG/1.5 mm²（用於 -44 VDC 至 -60 VDC PSU）接地線連接至 DC PSU。



注意：所有 DC 電源的連接工作應由合格的專家施作。

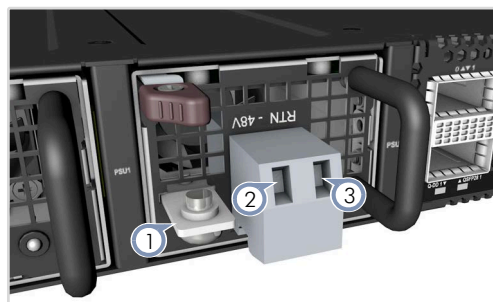

1. 連接接地線 / 保護接地端。
2. 連接 -44 – -60 VDC 線。
3. 連接 DC 回流線。



注釋：建議使用下列適用 DC 電源的项目：
 一條 UL 1015 AWG#10-14 絞線，最長 2m
 (-44VDC - -60VDC：輸入 +)
 一條 UL 1015 AWG#10-14 絞線，最長 2m
 (VDC 回傳：輸入 -)
 一條 UL 1015 AWG#10-14 絞線，最長 2m，
 (綠 / 黃) 綠色含黃色條紋 (PE)



注釋：DC 端子螺絲應鎖緊至最高 7 in-lbs 扭矩。

4 進行網路連線

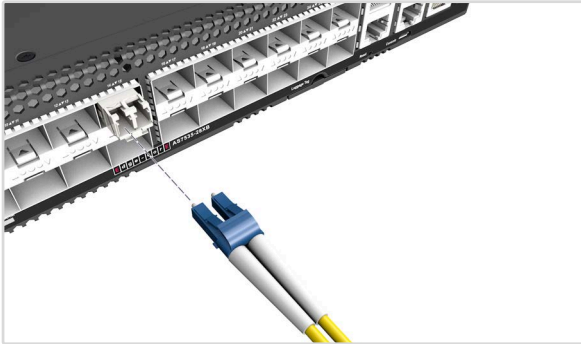

QSFP-DD/QSFP28/SFP28 連接埠

安裝收發器，然後將光纖電纜連接至收發器連接埠。或者直接連接 AEC/DAC 纜線至 QSFP-DD/QSFP28/SFP28 插槽。

QSFP-DD 連接埠支援下列收發器：

- 40GBASE-SR8、DR4、FR4、AEC 纜線

QSFP28 連接埠支援下列收發器：

- 100GBASE-SR4、PSM4、LR4、ER4、ZR4、CR4、AOC
- 40GBASE-SR4、PSM4、LR4

SFP28 連接埠支援下列收發器：

- 25GBASE-SR、LR、BX BiDi
- 10GBASE-SR、LR、CR、BX BiDi、T
- 1000BASE-SX、LX、BX BiDi、T

5 連接時序連接埠

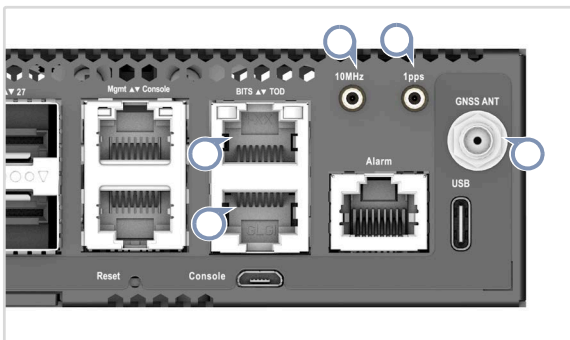

RJ-45 BITS/ToD

使用 5e 類或以上的雙絞線連接大樓綜合時脈供應裝置 (BITS) 和當日時間 (ToD) 連接埠至其他同步化裝置。

10MHz/1pps

使用同軸纜線連接 10 MHz 及 1 每秒脈衝 (1PPS) 連接埠至其他同步化裝置。

GNSS 天線

將外部 GPS 天線連接天線連接埠，用 GPS 時間進行時鐘同步。

6 進行管理連接

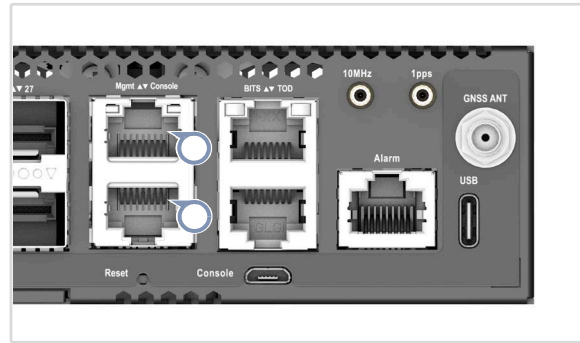

Mgmt RJ-45 連接埠

連接 Category 5、5e 或更好的雙絞線。

RJ-45 控制埠

利用 RJ-45-轉-DB-9 虛擬數據機電纜線 (未隨附) 來連接至執行虛擬終端機軟體的電腦。使用 USB-轉-公 DB-9 轉接纜線 (未隨附) 來連接至未配備 DB-9 序列埠的電腦。

設定序列連線：115200 bps、8 個字元、無奇偶 (檢驗碼)、1 個停止位元、8 個資料位元，並且無流量控制。

主控台纜線接腳輸出及配線：

裝置的 RJ-45 主控台	虛擬數據機	電腦的 9 接腳 DTE 連接埠
6 RXD (接收資料)	<-----	3 TXD (傳送資料)
3 TXD (傳送資料)	----->	2 RXD (接收資料)
4,5 SGND (訊號接地)	-----	5 SGND (訊號接地)

硬體規格

尺寸 (寬 x 深 x 高) 438.4 x 300 x 43.3 mm (17.26 x 11.81 x 1.7 in.)

重量 6.8 kg (14.99 lb) · 含兩個已安裝的 PSU

溫度 操作：-40° C 至 65° C (-40° F 至 149° F)
 運輸：-40° C 至 85° C (-40° F 至 185° F)
 儲存：-40° C 至 85° C (-40° F 至 185° F)

濕度 操作：5% 至 95% (無冷凝)

功耗 (25° C 時) 最高：383.6 W
 典型：164.03 W
 最小值：95.11 W

系統輸入額定值 AC 輸入：100–240 VAC · 50–60 Hz · 6.0–2.4 A
 100-120 VAC · 50/60 Hz · 最大 6.0 A 或
 200-240 Vac · 50/60 Hz · 最大 3.0 A
 DC 輸入：-44 – -60 VDC、15.5–9.6 A

符合法規

輻射 EN 55032
 EN 61000-3-2
 EN 61000-3-3
 FCC Title 47, Part 15, Subpart B, Class A
 VCCI-CISPR 32
 BSMI Class A

耐受 EN 55035
 IEC 61000-4-2/3/4/5/6/8/11

環境 Storage:
 ■ ETSI EN 300 019-1-1 Class 1.1
 ■ Temperature: -40° C to 85° C (-40° F to 185° F)
 Transportation:
 ■ ETSI EN 300 019-1-2 Class 2.3
 ■ Temperature: -40° C to 85° C (-40° F to 185° F)
 Operating Conditions:
 ■ ETSI EN 300 019-1-3 Class 3.2
 ■ Temperature: -40° C to 65° C (-40° F to 149° F)
 ■ Relative Humidity: 5% to 95%

安全性 UL (CSA 22.2 No 62368-1 & UL 62368-1)
 CB (IEC/EN 62368-1, 2nd & 3rd Ed)
 BSMI CNS 15598-1
