

# Quick Start Guide

## Ethernet Switch

AS7535-28XB



www.edge-core.com

### Package Contents



1



2



3



4



5

1. AS7535-28XB (includes 2 PSUs and 6 fan trays)
2. Rack Mounting Kit—2 brackets and 8 screws
3. Grounding kit—grounding lug, 2 screws, and 2 washers

4. (Optional) AC power cord
5. Documentation—*Quick Start Guide* (this document) and *Safety and Regulatory Information*

### Overview

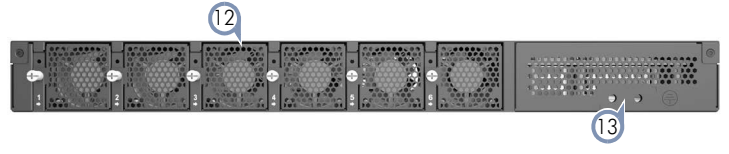

1. 2 x DC or AC PSUs
2. 2 x 100G QSFP28 ports
3. 2 x 400G QSFP-DD ports
4. 24 x 25G SFP28 ports
5. Product tag
6. Management I/O: 1000BASE-T RJ-45, RJ-45 console, Micro-USB console, reset button

7. BITS/ToD RJ-45 timing ports
8. 10MHz/1PPS I/O
9. GNSS antenna
10. USB Type C storage port
11. RJ-45 alarm port
12. 6 x fan trays
13. Grounding screw

### Status LEDs

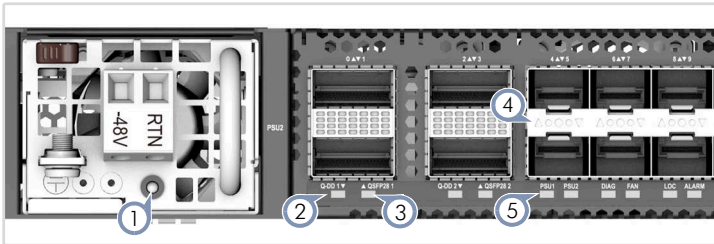

1. **PSU LED:** Green (OK), Amber (fault)
2. **QSFP-DD Port LEDs:** Blue (400G), Cyan (200G), Green (100G), Yellow (50G)
3. **QSFP28 Port LEDs:** Green (100G), Cyan (50G), Magenta (40G), Blue (25G), Yellow (10G)
4. **SFP28 Port LEDs:** Blue (25G), Green (10G), Cyan (1G)

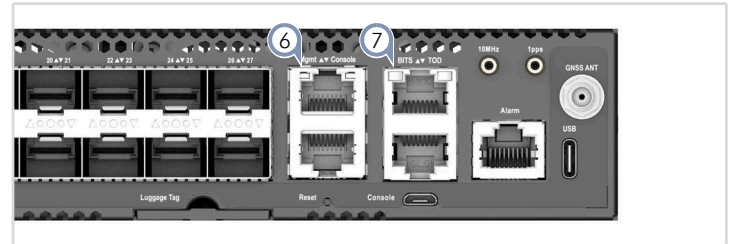

5. **System LEDs:**  
PSU1/2 — Green (OK), Amber (fault)  
DIAG — Green (OK), Orange (fault detected)  
FAN — Green (OK), Orange (fault)  
LOC — Blinking Blue (OK)  
ALARM — Green (OK), Red (alarm)
6. **RJ-45 Management Port LEDs:** Left (link), Right (activity)
7. **BITS/ToD LEDs:** Green (valid BITS), Blinking Green (1PPS ToD)

### FRU Replacement

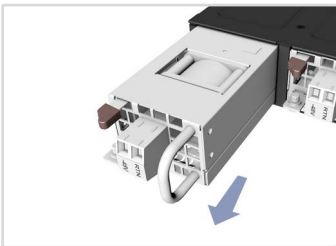

#### PSU Replacement

1. Remove the power cord.
2. Press the release latch and remove the PSU.
3. Install replacement PSU.

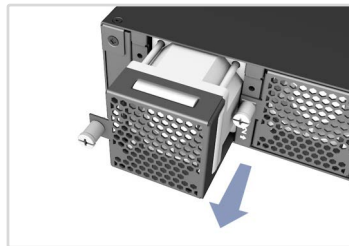

#### Fan Tray Replacement

1. Loosen the fan tray screw.
2. Pull out and remove the fan tray.
3. Install replacement fan tray.



## Installation



**Warning:** For a safe and reliable installation, use only the accessories and screws provided with the device. Use of other accessories and screws could result in damage to the unit. Any damages incurred by using unapproved accessories are not covered by the warranty.

**Avertissement:** Pour une installation sûre et fiable, utilisez uniquement les accessoires et les vis fournies avec l'appareil. L'utilisation d'autres accessoires et vis pourrait endommager l'appareil. Les dommages causés par l'utilisation d'accessoires non approuvés ne sont pas couverts par la garantie.



**Caution:** The device must be installed in a restricted-access location.

**Attention:** L'appareil doit être installé dans un emplacement à accès restreint.



**Note:** The device has the Open Network Install Environment (ONIE) software installer preloaded, but no software image. Information about compatible software can be found at [www.edge-core.com](http://www.edge-core.com).



**Note:** The drawings in this document are for illustration only and may not match your particular model.

## 1 Mount the Device in an EIA-310 Rack

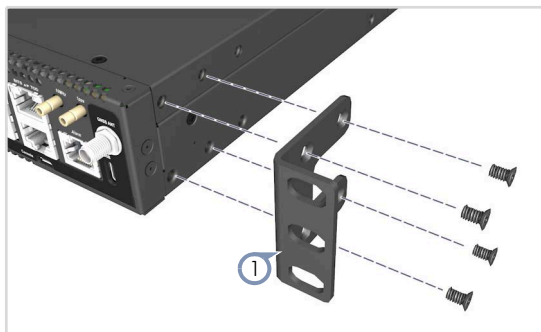

1. For a 300mm-deep rack, use the four front screw holes to attach each of the brackets to the device with four of the included bracket screws. (For a 280mm-deep rack, use the four recessed screw holes.)

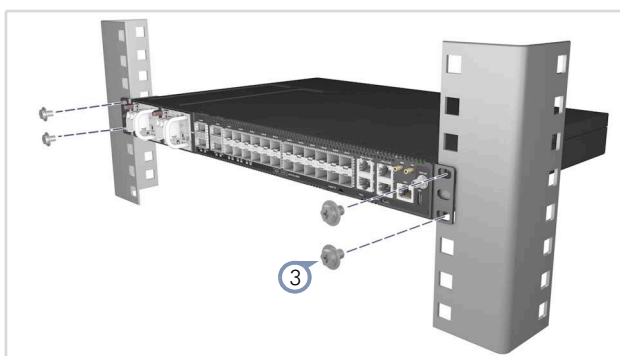

2. Use the screws and cage/clip nuts supplied with the rack to secure the device in the rack.

## 2 Ground the Device

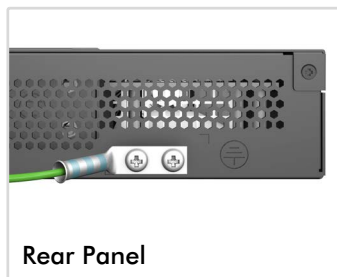

Rear Panel

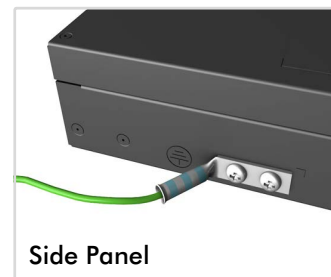

Side Panel

### Verify Rack Ground

Ensure the rack is properly grounded and in compliance with international and local standards. Verify that there is a good electrical connection to the grounding point on the rack (no paint or isolating surface treatment).

### Attach Grounding Wire

Attach the grounding wire (#14 AWG/1.5 mm<sup>2</sup>, green with yellow stripe) to the grounding point on the device's rear panel or side panel. Then connect the other end of the wire to rack ground.



**Caution:** The earth connection must not be removed unless all supply connections have been disconnected.

**Attention:** Le raccordement à la terre ne doit pas être retiré sauf si toutes les connexions d'alimentation ont été débranchées.

## 3 Connect Power

### a. AC Power

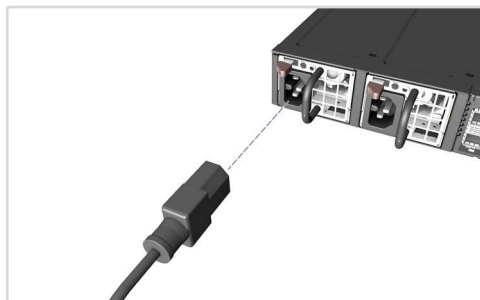

Install one or two AC PSUs in the device, if they are not already installed in the factory. Then connect an external AC power source to the PSUs.

### b. DC Power

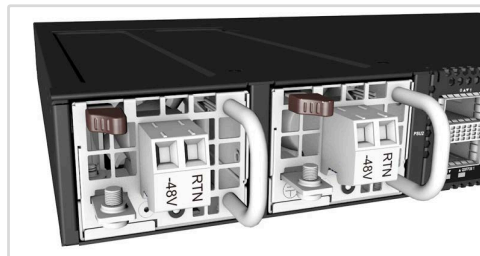

Install one or two DC PSUs (part number CDR-6011-6M4 only) in the device, if they are not already installed in the factory.

Connect an external DC power source to the PSUs. Or, connect to a no-tolerance DC mains supply with a UL/CSA-approved circuit breaker rated at 16 A.

**Caution:** Before connecting power supply cables to the device, ensure that power to the feed lines is turned off at the supply circuit breaker or disconnected from the power bus.  
**Attention:** Avant de connecter les câbles d'alimentation à l'appareil, assurez-vous que l'alimentation des lignes d'alimentation est coupée au niveau du disjoncteur d'alimentation ou déconnectée du bus d'alimentation.

**Caution:** Use a UL/IEC/EN 60950-1 and/or 62368-1 certified power supply to connect to a DC converter, and a #14 AWG/1.5 mm<sup>2</sup> (for -44 VDC to -60 VDC PSU) wire to connect to a DC PSU.

**Attention:** Utilisez une alimentation certifiée UL/IEC/EN 60950-1 et/ou 62368-1 pour le connecter à un convertisseur CC et un câble AWG #14/1.5 mm<sup>2</sup> (pour -44 VDC à -60 VDC) pour vous connecter à une alimentation CC.

**Caution:** All DC power connections should be performed by a qualified professional.

**Attention:** Toutes les connexions d'alimentation CC doivent être effectuées par un professionnel qualifié.

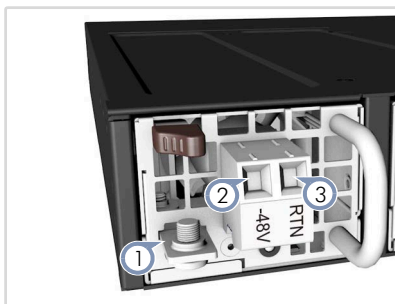

1. Connect the ground wire / protective earth.
2. Connect the -44 – -60 VDC wire.
3. Connect the DC return wire.

**Note:** It is suggested to use the following for DC power:  
 One UL 1015 AWG#10-14 stranded wire, 2m maximum (-44VDC – -60VDC: Input+)  
 One UL 1015 AWG#10-14 stranded wire, 2m maximum (VDC return: Input-)  
 One UL 1015 AWG#10-14 stranded wire, 2m maximum, (green/yellow) green with yellow stripe (PE)

**Note:** The DC terminal screws should be tightened to a torque of 7 in-lbs maximum.

#### 4 Make Network Connections

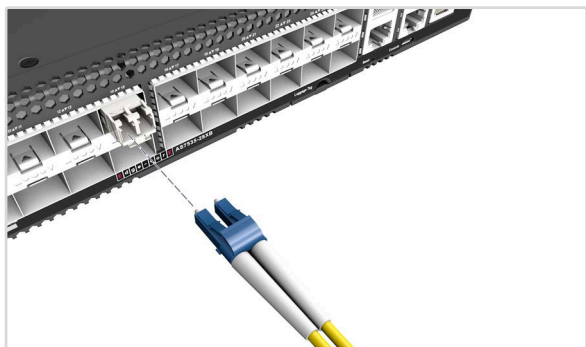

##### QSFP-DD/QSFP28/SFP28 Ports

Install transceivers and then connect fiber optic cabling to the transceiver ports. Alternatively, connect AEC/AOC/DAC cables directly to the QSFP-DD/QSFP28/SFP28 slots.

The following transceivers are supported in the QSFP-DD ports:

- 400GBASE-SR8, DR4, FR4, AEC cable

The following transceivers are supported in the QSFP28 ports:

- 100GBASE-SR4, PSM4, LR4, ER4, ZR4, CR4, AOC
- 40GBASE-SR4, PSM4, LR4

The following transceivers are supported in the SFP28 ports:

- 25GBASE-SR, LR, BX BiDi
- 10GBASE-SR, LR, CR, BX BiDi, T
- 1000BASE-SX, LX, BX BiDi, T

#### 5 Connect Timing Ports

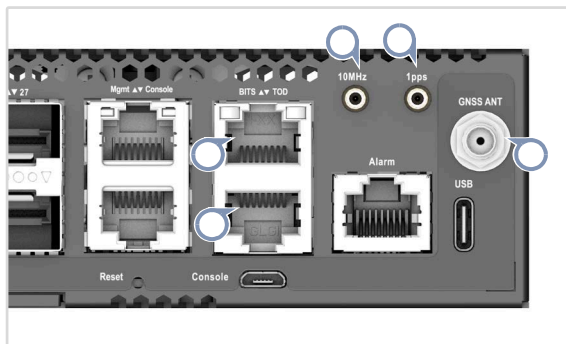

##### RJ-45 BITS/ToD

Use Cat. 5e or better twisted-pair cables to connect the Building-Integrated Timing Supply (BITS) and Time of Day (ToD) ports to other synchronized devices.

##### 10MHz/1pps

Use coax cables to connect the 10 MHz and 1-pulse-per-second (1PPS) ports to other synchronized devices.

##### GNSS Antenna

Attach an external antenna to the GNSS antenna port for clock synchronization with GPS time.

#### 6 Make Management Connections

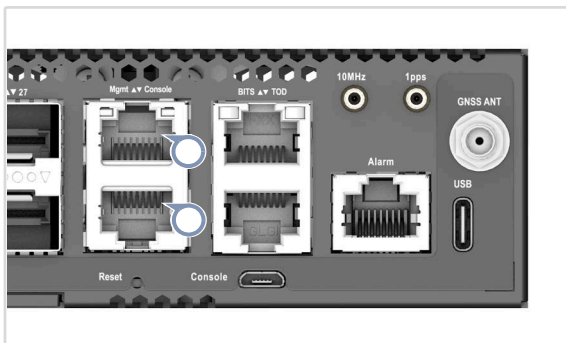

##### Mgmt RJ-45 Port

Connect Category 5, 5e or better twisted-pair cable.

##### RJ-45 Console Port

Use an RJ-45-to-DB-9 null-modem console cable (not included) to connect to a PC running terminal emulator software. Use a USB-to-male DB-9 adapter cable (not included) for connections to PCs that do not have a DB-9 serial port.

Configure the serial connection: 115200 bps, 8 characters, no parity, one stop bit, 8 data bits, and no flow control.

Console cable pinouts and wiring:

Device's RJ-45 Console	Null Modem	PC's 9-Pin DTE Port
6 RXD (receive data)	<-----	3 TXD (transmit data)
3 TXD (transmit data)	----->	2 RXD (receive data)
4,5 SGND (signal ground)	-----	5 SGND (signal ground)

---

## Hardware Specifications

Size (WxDxH)	438.4 x 300 x 43.3 mm (17.26 x 11.81 x 1.7 in.)
Weight	7.5 kg (16.53 lb), with two installed PSUs
Temperature	Operating: -40° C to 65° C (-40° F to 149° F) Transportation: -40° C to 85° C (-40° F to 185° F) Storage: -40° C to 85° C (-40° F to 185° F)
Humidity	Operating: 5% to 95% (non-condensing)
Power Consumption (at 25° C)	Maximum: 383.6 W Typical: 164.03 W Minimum: 95.11 W
System Input Rating	AC Input: 100–240 VAC, 50–60 Hz, 6.0–2.4 A DC Input: -44 – -60 VDC, 15.5–9.6 A

---

## Regulatory Compliances

Emissions	EN 55032:2015/A1:2020, Class A EN 61000-3-2:2019/A1:2021 EN 61000-3-3:2013+A1:2019 FCC Title 47, Part 15, Subpart B, Class A VCCI-CISPR 32:2016, Class A
Immunity	EN 55035:2017/A11:2020 EN 55024:2010+A1:2015 IEC 61000-4-2/3/4/5/6/8/11
Environmental	Storage: <ul style="list-style-type: none"> <li>■ ETSI EN 300 019-1-1 Class 1.1</li> <li>■ Temperature: -40° C to 85° C (-40° F to 185° F)</li> </ul> Transportation: <ul style="list-style-type: none"> <li>■ ETSI EN 300 019-1-2 Class 2.3</li> <li>■ Temperature: -40° C to 85° C (-40° F to 185° F)</li> </ul> Operating Conditions: <ul style="list-style-type: none"> <li>■ ETSI EN 300 019-1-3 Class 3.2</li> <li>■ Temperature: -40° C to 65° C (-40° F to 149° F)</li> <li>■ Relative Humidity: 5% to 95%</li> </ul>
Safety	UL (CSA 22.2 No 62368-1 & UL 62368-1) CB (IEC/EN 60950-1 & IEC/EN 62368-1)

---



---

## Warranty Information and Technical Support

Registering your product enables you to receive a more efficient warranty service. Be sure to register at [www.edge-core.com](http://www.edge-core.com).

---